



ZODIAC

C Series Troubleshooting Manual



IMPORTANT SAFETY INFORMATION

READ AND FOLLOW ALL INSTRUCTIONS.

NOTE: This manual is for use by licensed electricians or trained pool professionals only. No other person is to install, service or troubleshoot this C Series Chlorinator.



WARNING

Failure to heed the following warnings can result in permanent injury, electrocution or drowning.

ELECTRICAL HAZARD

- To reduce risk of electrical shock
 - Make sure all power to pool equipment area is off prior to any installation or removal of Clearwater components.
 - Replace damaged power pack cord immediately.
 - Do not bury cord. Locate cord to minimize abuse from lawn mowers, hedge trimmers and other equipment.
- Severe shock or injury will likely occur as a result of a drill or drill cord coming in contact with water. Never allow electric drill or cord to come in contact with water. Only plug drill into a Class A (5 Milliampere Trip) protected Ground Fault Circuit Interrupter (GFCI) in accordance with the National Electrical Code Section 680 (USA only). Please see your drill owner's manual for further safety precautions.
- Install the power pack at least 10 feet from the inside walls of a pool to prevent any possibility of the unit coming in contact with water.
- Your Clearwater Chlorinator has been designed with an electronic flow switch. This device automatically switches the chlorinator 'OFF' when the water through the cell stops. To prevent cell damage and personal injury, do not in any way interfere with this system which has been designed for your protection.

CHEMICAL USE HAZARD

- To avoid personal injury when working with pool chemicals, always wear rubber gloves and eye protection and work in a well-ventilated area. Use caution when choosing a location to open and use chemicals as they may damage any surface in which they come in contact.
- The addition of certain chemicals can reduce the effectiveness of chlorine. Always make sure that proper residual chlorine levels are maintained to avoid personal injury.
- This product manufactures chlorine. Individuals with any type of chlorine sensitivity should take the appropriate precautions to avoid injury or illness.

EQUIPMENT WATER PRESSURE HAZARD

- Always turn pump off prior to installing or removing any Clearwater cell. Your pump/filter system is operated under pressure and the pressure must be released before you begin work. Please see your pump/filter owner's manual for further instructions.
- To avoid cell damage, water pressure in the cell must not exceed 29 psi (200kPa)

PREVENT CHILD INJURY AND DROWNING

- To reduce the risk of injury, do not permit children to operate this product.
- Do not let anyone, especially small children, sit, step, lean, or climb on any equipment installed as part of your pool's operational system. Unless otherwise stated, ALL components of your pool's operational system should be located at least 3 feet from the pool so children cannot use the equipment to gain access and be injured or drown.



CAUTION

Failure to heed the following warnings could cause damage to pool equipment or personal injury.

- Chlorinator must be installed and operated as specified.
- Scratching or bending plates in cell housing can reduce cell life.
- Power to the C Series should be turned off before unplugging the cell connectors to prevent cell damage and low voltage sparks.
- Keep the cell terminals protected with a light coating of silicone grease to allow for a positive electric connection. Use of any other type of grease may damage the terminal seals and 'o' rings. Do not immerse these terminals in acid wash solution, and avoid accidental contact with salt water.
- Water above the temperature of 104 degrees F (40 degrees C) flowing through the cell can cause plastic cell to discolor.
- Power pack must not be installed directly above any other heat source such as filter, pump or heater. It must be at least 1 Ft. (300 mm) from the ground to allow free circulation of air around it. It must not be installed in a closed box. If the power pack is to be installed on a post, then it must be centrally positioned on a flat panel of suitable waterproof material at least 10 inches (240mm) wide and 18 inches (440mm) high.
- Check the cell frequently to prevent the accumulation of pool debris that for any reason may have by-passed the pool filter.

Table of Contents

Safety Instructions2	Bridge Rectifier	
Look / Feel3	Checking Diode / Replacing Rectifier16
Testing Power Path4	Red Line Connector Assembly (Large)18
Red Light On5	Red Line Connector Assembly (Small)19
Amber Light On OR Green & Amber Lights On6	Wire Color Locations19
No Lights / No Output7	Power Cord20
Meter Will Not Go to 100%8	Output Cord21
Meter Not Moving9	Transformer22
Output Meter10	Cell23	
Shunt10	Heavy Build-Up on Cell23
No Chlorine Reading11	Replace Cell24
Cell Terminals are Hot12	Cell Cap24
Tripping House Breaker12	Replacing Blank End Cap24
Power PCB13	Replace Electrode End Cap25
Replace Fuse14	Exploded Diagram26
Output Control PCB15	Parts List27

Look/Feel

Before removing chlorinator cover, check the following:

1. Is the pool pump on?
2. Is the output control turned up?
3. Does the output meter function? (If NO, see Output Meter pg. 10)
4. Is the output cord attached to the cell?
5. Is the black sensor wire attached to the sensor post on the cell?
(see Red Light On pg. 5)
6. Can you see production in the cell? (see No Chlorine Reading pg. 11)
7. Is there heavy build-up on the cell? (see Heavy Build-up on Cell pg. 23)

After checking the above items:

1. Turn off power supply.
2. Remove chlorinator from wall.
3. Remove 4 screws to remove cover and check the following:
 - Are there any visible burn marks anywhere inside the chlorinator?
 - Is there any visible water damage?
 - Are there any loose wires or screws?
 - Is the fuse on the PC board blown?

Testing the Power Path

Set volt-meter to AC volts and test between the following points:

- 1. E&F = 220V + or - 10%.
- 2. C&D = Same as E&F.
- 3. A&B = Same or less than E&F (increased conductivity results in decreased voltage to keep PCB cool and protect electronics).

If result is 0, replace fuse. (see Replace Fuse pg. 14)

- 4. H&G = As printed on transformer (this will drop as A&B drops).
- 5. K&M = Same as H&G

Set volt-meter to DC volts and test between the following points:

- 1. J&N = Up to 2 volts lower than K&M.

If more than 2 volt drop then rectifier is bad. (see Bridge Rectifier pg. 16)

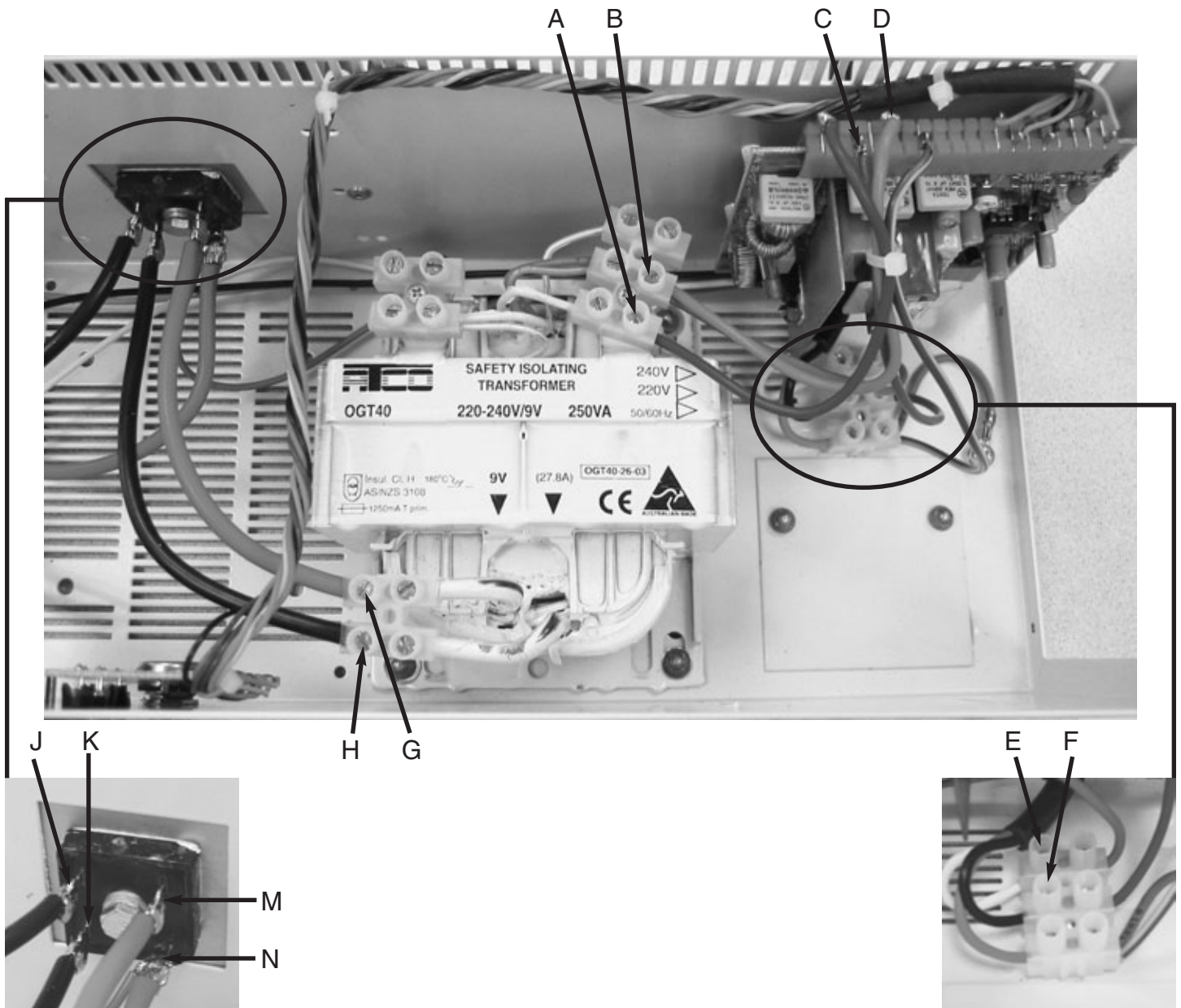

Red Light On

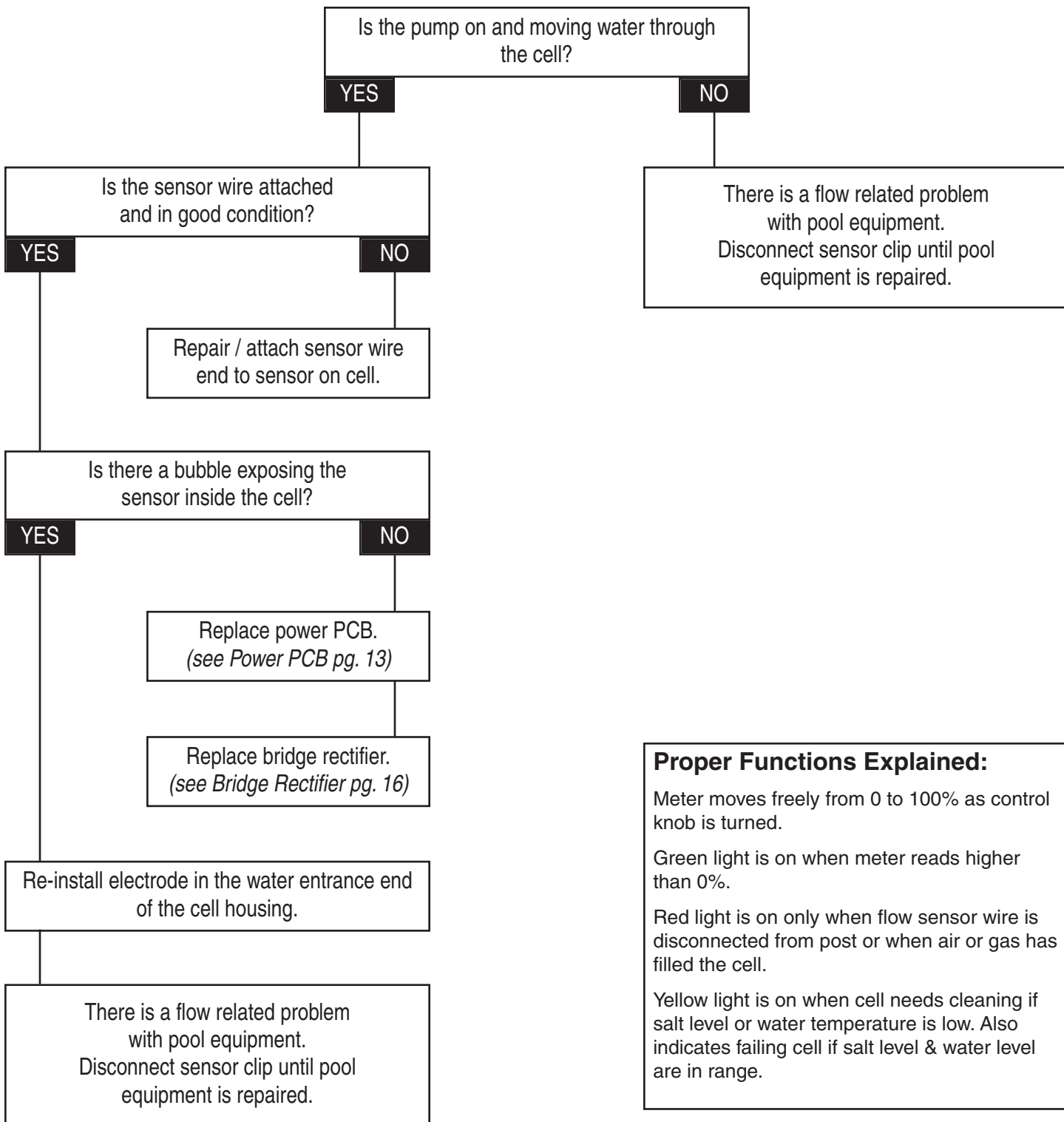

Proper Functions Explained:

Meter moves freely from 0 to 100% as control knob is turned.

Green light is on when meter reads higher than 0%.

Red light is on only when flow sensor wire is disconnected from post or when air or gas has filled the cell.

Yellow light is on when cell needs cleaning if salt level or water temperature is low. Also indicates failing cell if salt level & water level are in range.

Amber Light On or Green & Amber Lights Are On

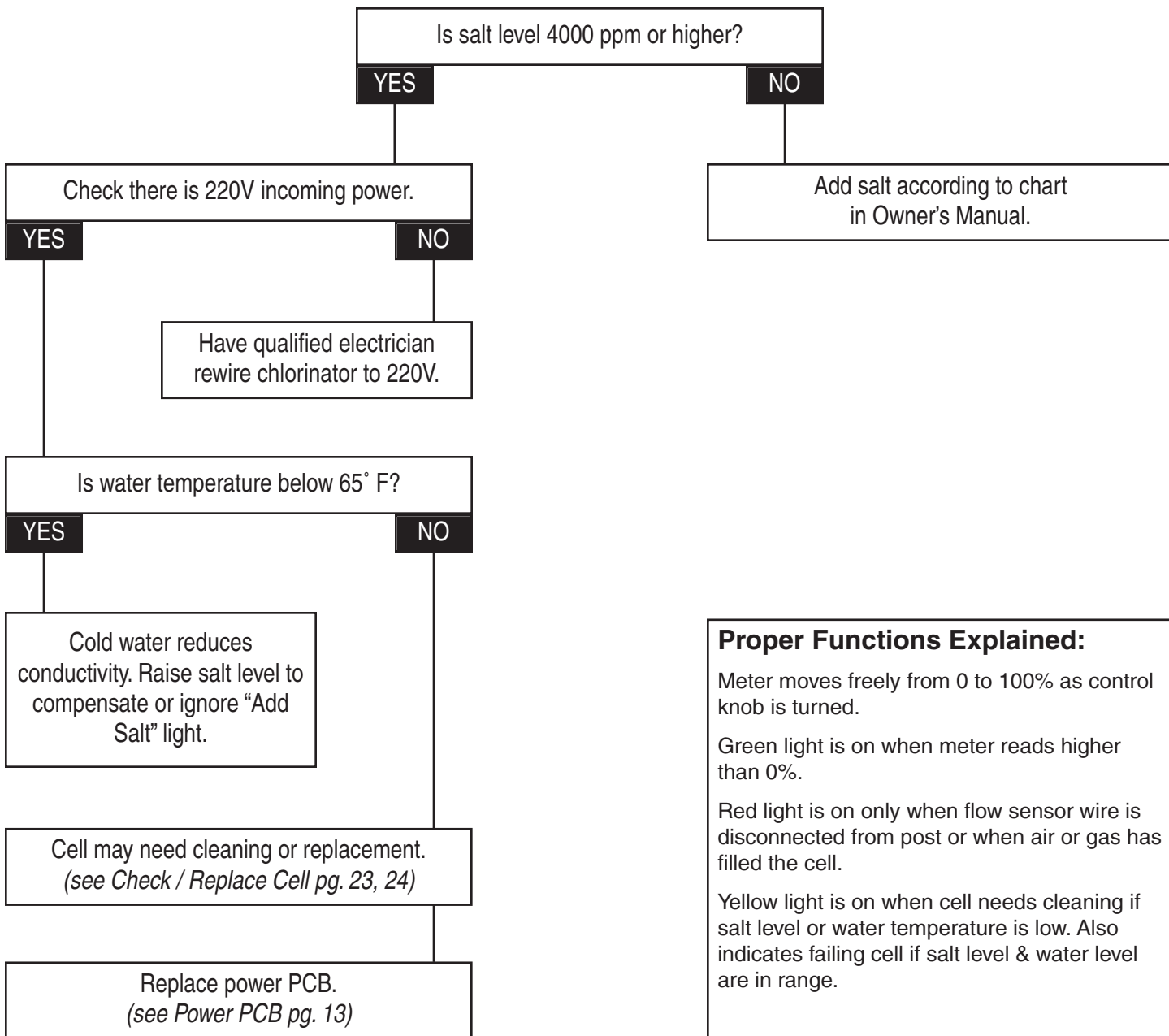

Proper Functions Explained:

Meter moves freely from 0 to 100% as control knob is turned.

Green light is on when meter reads higher than 0%.

Red light is on only when flow sensor wire is disconnected from post or when air or gas has filled the cell.

Yellow light is on when cell needs cleaning if salt level or water temperature is low. Also indicates failing cell if salt level & water level are in range.

No Lights / No Output

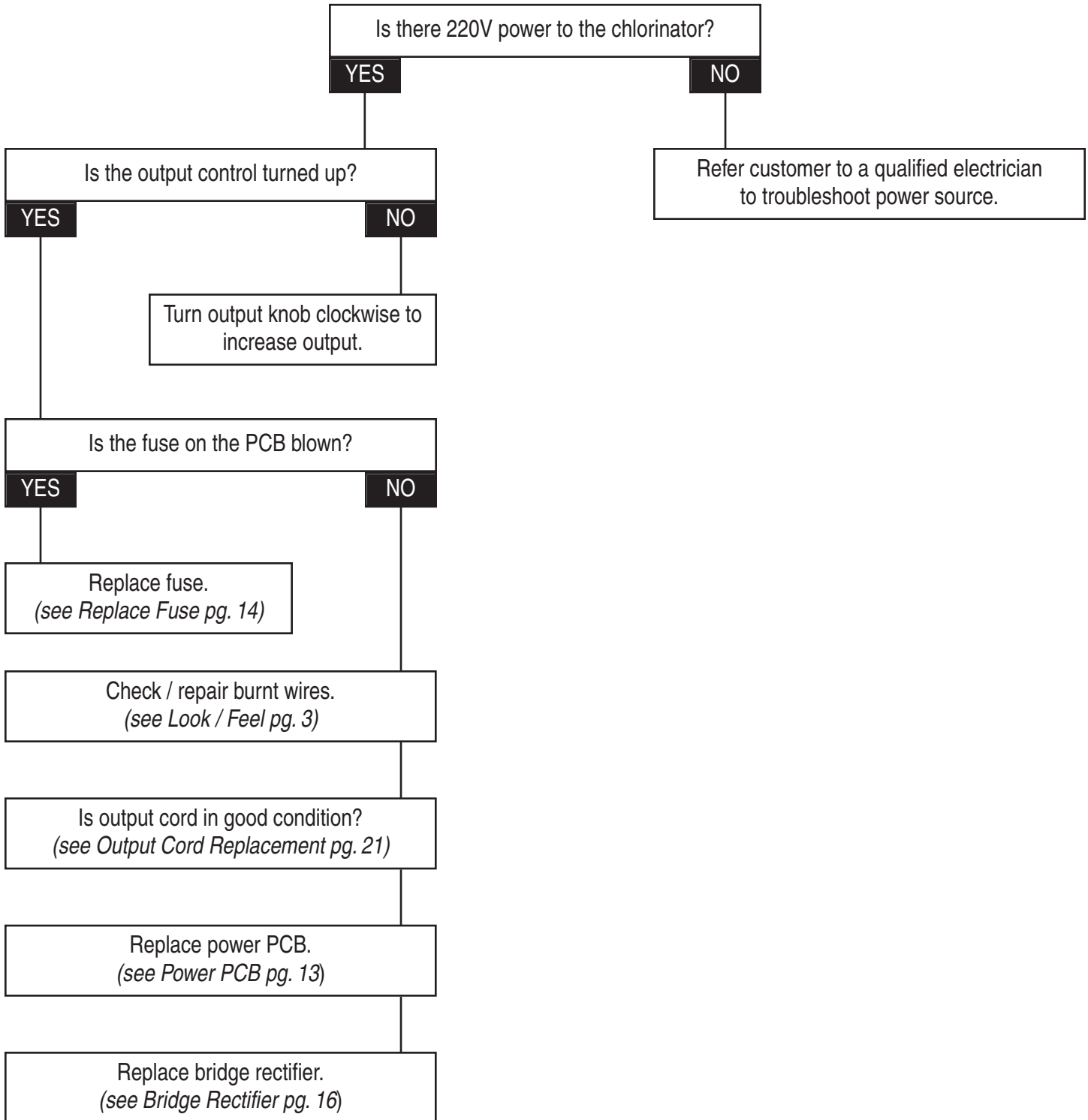

Meter Will Not Go to 100%

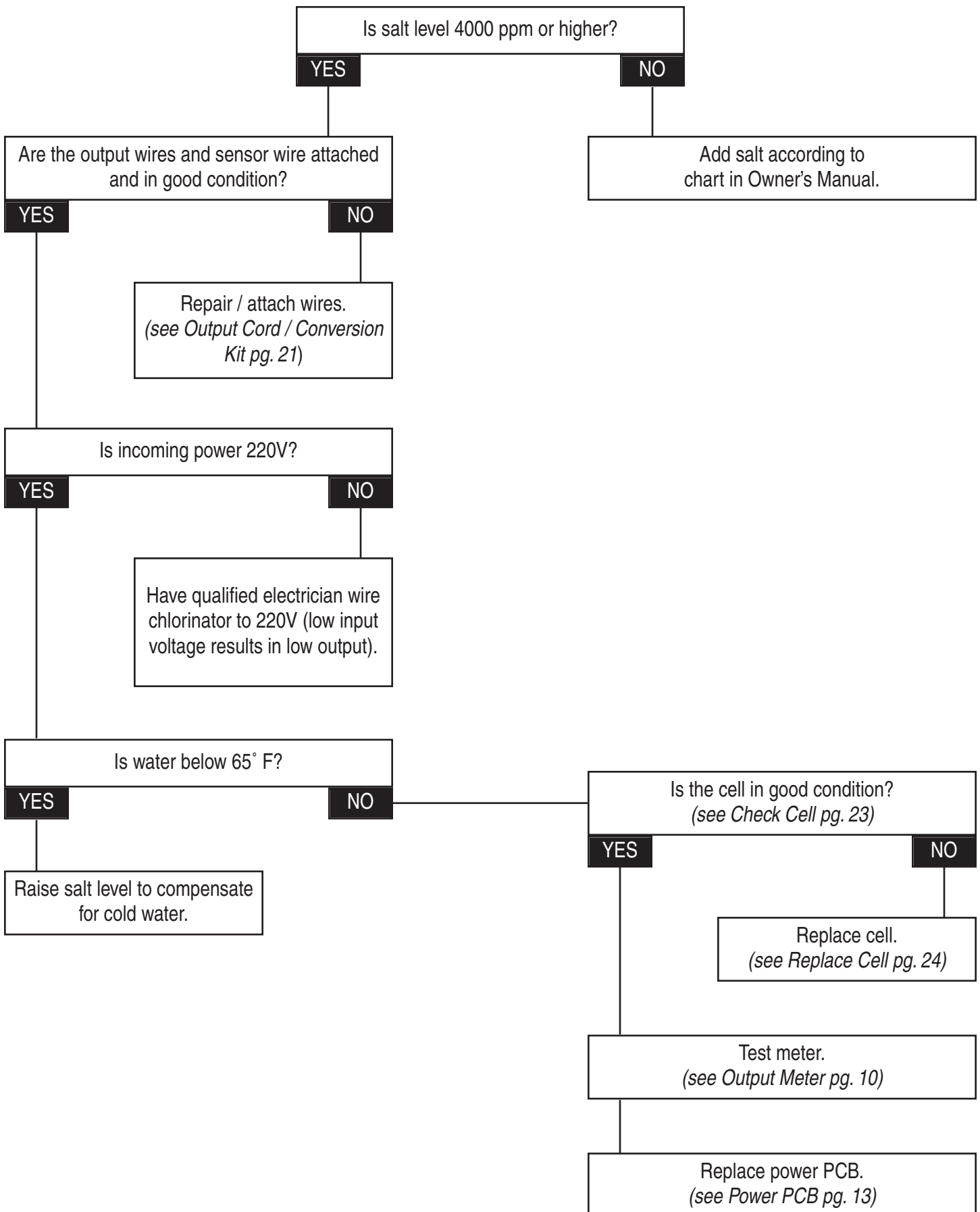

Meter Not Moving

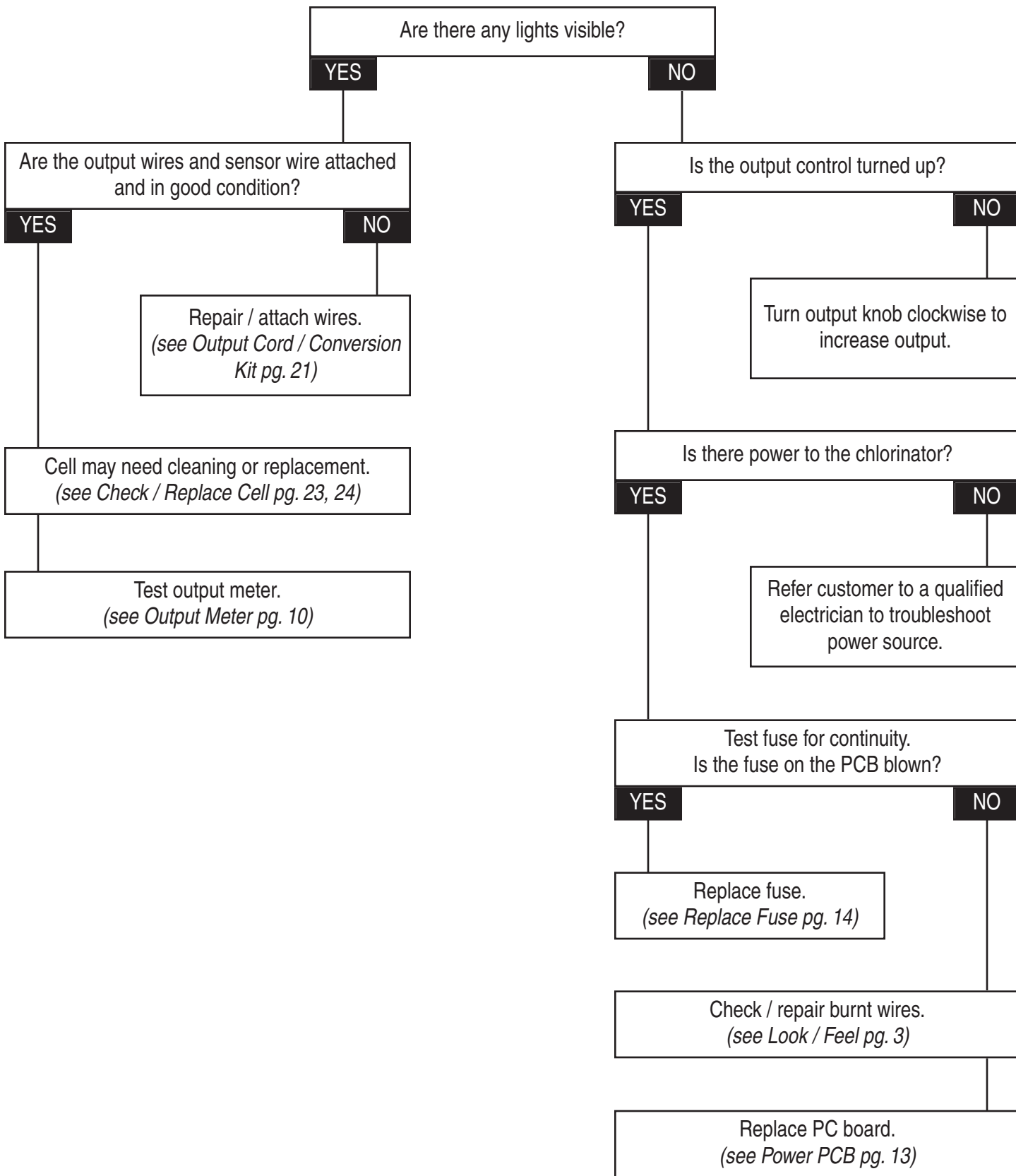

Output Meter

Testing

1. Turn off power supply.
2. Remove chlorinator from wall bracket.
3. Remove 4 screws to remove cover.
4. Check for loose wire connections on back of meter (this may be the only problem with the meter). If tight, continue testing.
5. Turn on power supply.
6. Touch terminals of new meter to terminals of old meter firmly (use caution not to touch any other live wires).
7. If new meter reads the same as old meter, do not replace it and find fault elsewhere. If new meter reads correctly, skip to replacement section below.
8. Turn off power supply.
9. Replace cover with 4 screws.
10. Replace chlorinator on wall bracket.
11. Turn on power supply.

Replacement

1. Turn off power supply.
2. Remove chlorinator from wall bracket.
3. Remove 4 screws to remove cover.
4. Remove 2 screws to remove shunt and wires from back of meter.
5. Remove nuts and washers from 4 corner bolts of meter.
6. Pull old meter through face of chlorinator.
7. Insert new meter through face of chlorinator.
8. Replace nuts and washers on 4 corner bolts of meter.
9. Position and hold in place the shunt and wires with 2 screws (tighten firmly).
10. Replace cover with 4 screws.
11. Replace chlorinator on wall bracket.
12. Turn on power supply.

Shunt

Be sure screws holding the shunt in place are tight.

Replacement

1. Remove 2 screws holding shunt in place.
2. Position and hold in place the new shunt and wires with 2 screws (tighten firmly).

No Chlorine Reading

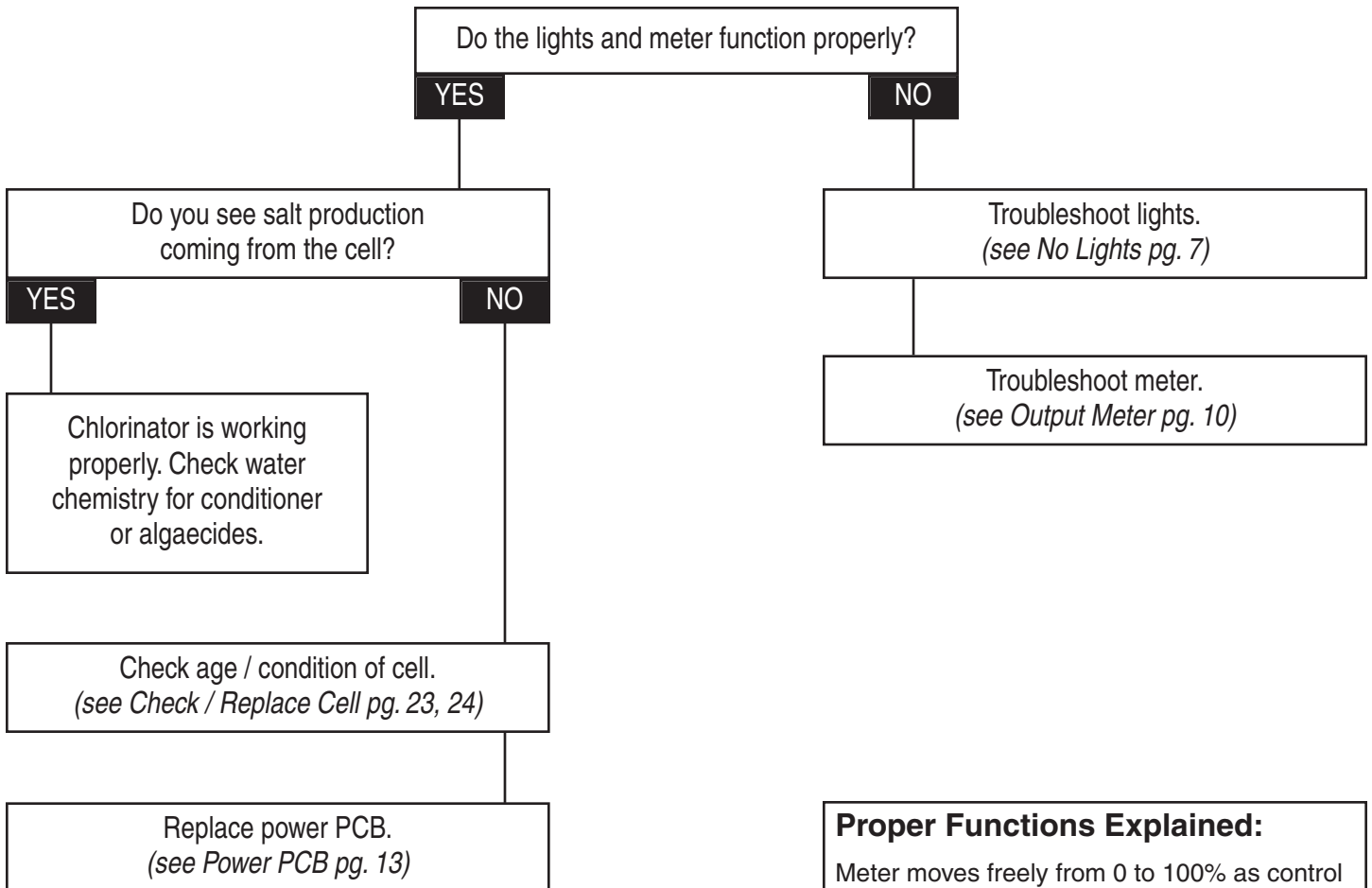

Proper Functions Explained:

Meter moves freely from 0 to 100% as control knob is turned.

Green light is on when meter reads higher than 0%.

Red light is on only when flow sensor wire is disconnected from post or when air or gas has filled the cell.

Yellow light is on when cell needs cleaning if salt level or water temperature is low. Also indicates failing cell if salt level & water level are in range.

Cell Terminals are Hot

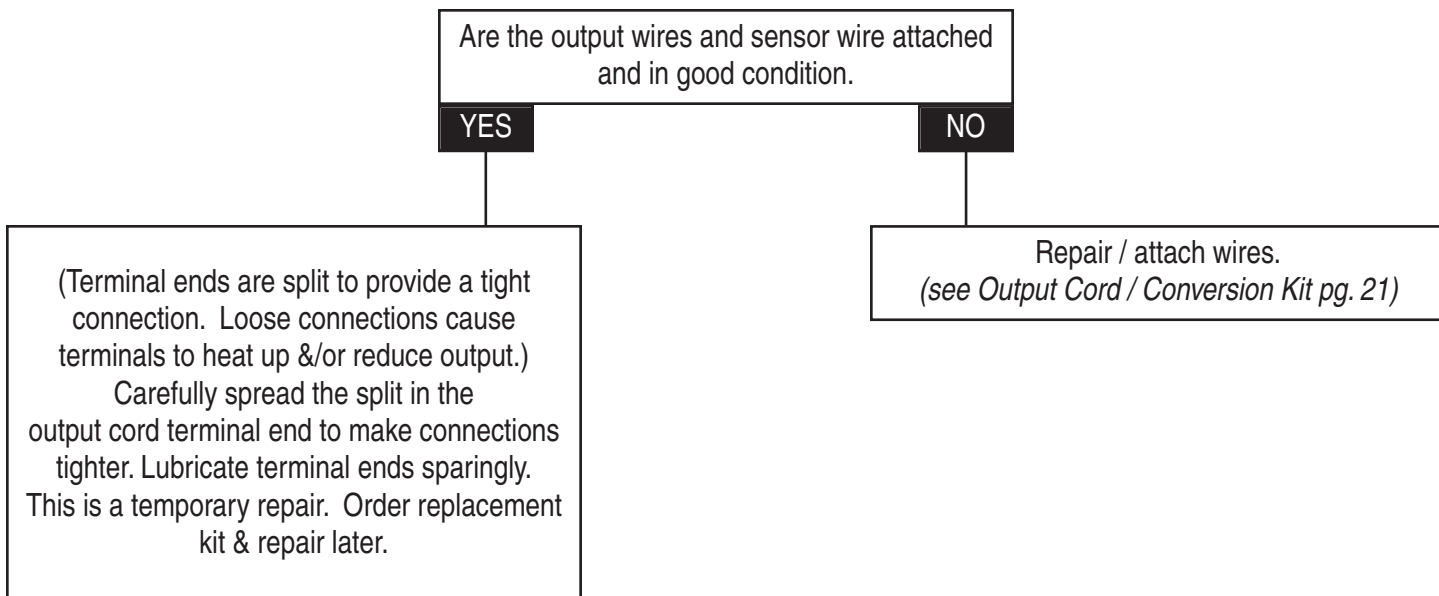

Tripping House Breaker

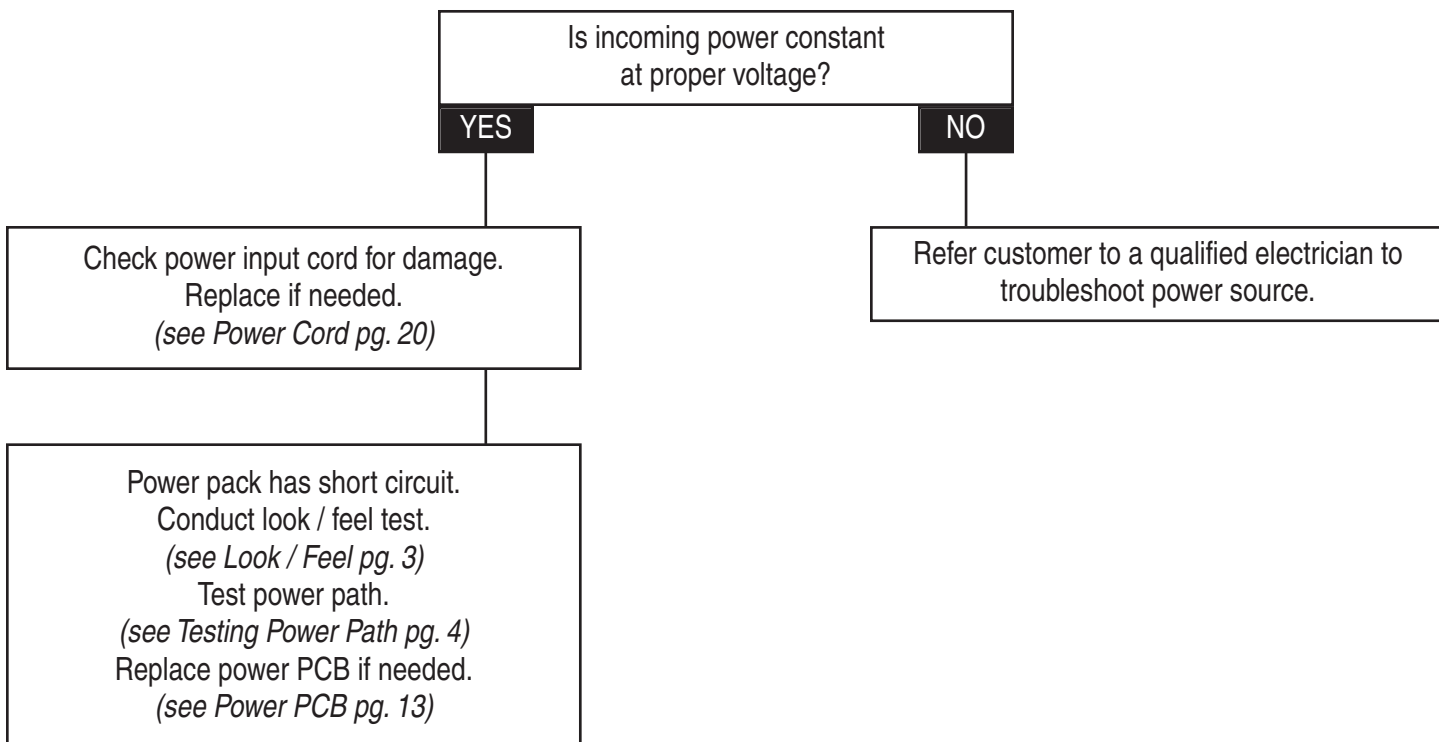

Power PCB

Replacement

1. Disconnect power supply.
2. Remove chlorinator from wall bracket.
3. Remove 4 screws to remove cover.
4. Use flat blade screwdriver to pry the red line connectors off top and bottom edges of PCB. Inspect the red line connectors for burn marks, replace if needed.
5. Insert screwdriver between PCB and unit back and pry forward to remove PCB from 4 stand-offs.
6. Replace any of the 4 stand-offs that were damaged beyond use.
7. Push small red line connector onto bottom edge of new PCB (Note: blank plate in red line connector lines up with slot in edge of PCB).
8. Push new PCB onto 4 stand-offs (there are 4 extra holes on PCB - see picture).
9. Push large red line connector onto top edge of PCB (Note: blank plates in red line connector line up with slots in edge of PCB).
10. Replace cover with 4 screws.
11. Replace chlorinator on wall bracket.
12. Connect power supply.
13. Test run chlorinator.

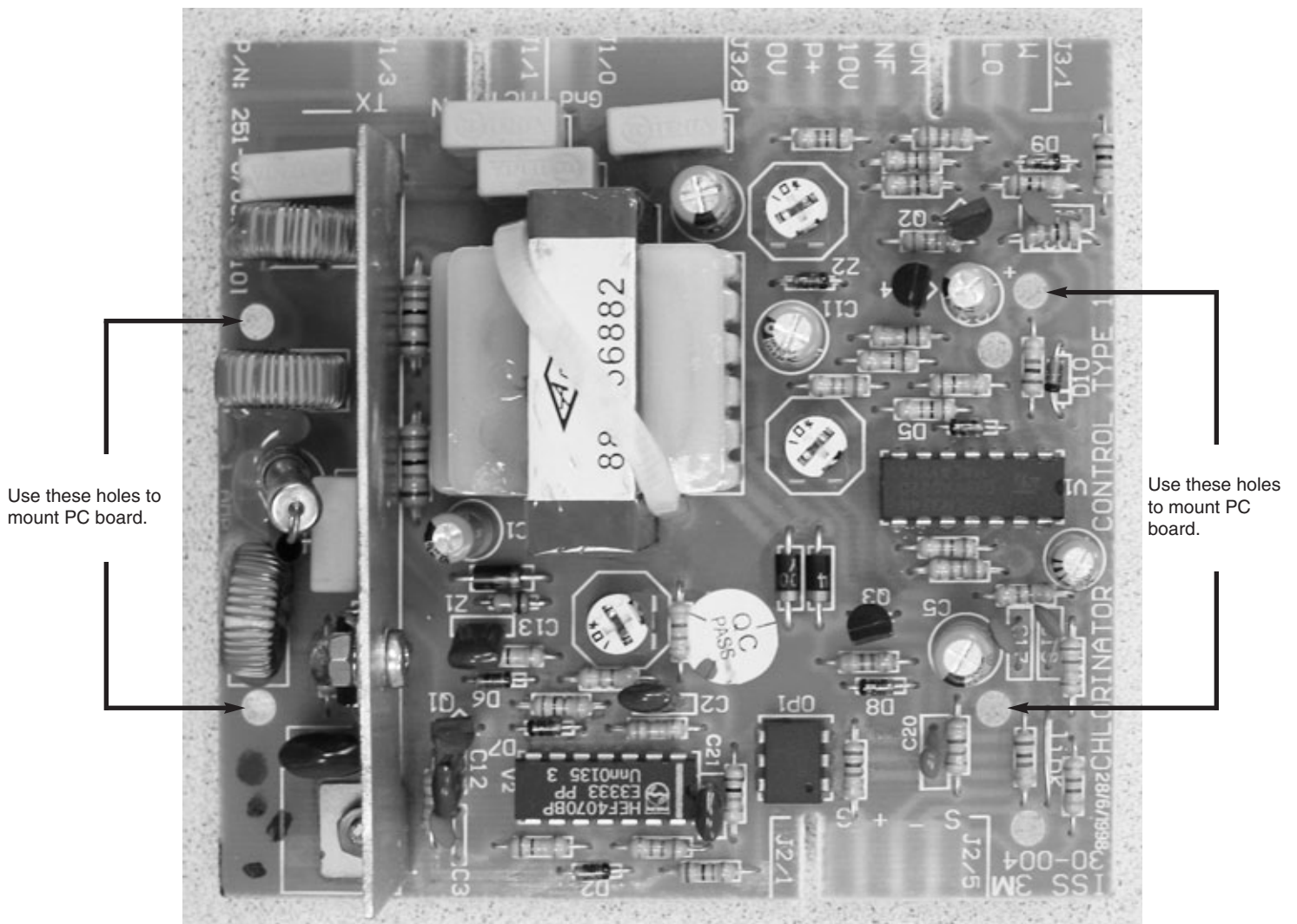

Replace Fuse

1. Follow PCB Replacement steps 1-6.
2. Use small tip soldering iron to loosen solder on back of PCB and remove fuse with wire tails from PCB.
3. Use small tubing from old fuse and slip over wire tail of new fuse.
4. Fold covered wire tail 180 degrees.
5. Push both wire tails through holes in PCB (either wire goes in either hole).
6. Solder tails from back side of PCB.
7. Trim excess wire tail from back of PCB.
8. Follow PCB Replacement steps 7-12.

Fuse located here on
Power PC board.



Output Control PCB

To Remove

1. Disconnect power supply.
2. Remove chlorinator from wall bracket.
3. Remove 4 screws to remove cover.
4. Clip 3 zip ties that hold wire harness to back of unit.
5. Use flat blade screwdriver to pull red line connector off top edge of PCB.
6. Use heavy duty snips to cut red line connector in half.
7. Push power input half back onto edge of PCB (Note: locator plates in red line connector line up with slots in edge of PCB).
8. Turn output control knob counter-clockwise to expose setscrew in knob.
9. Loosen setscrew and remove output control knob.
10. Remove retaining nut and washer from output control shaft.
11. Gently push all 3 lights and shaft through face from front of chlorinator and remove assembly.

Replacement

12. Cut new red line connector assembly in half and set aside power input half.
13. Remove nut from shaft of new output control board.
14. Gently push all 3 lights and shaft in place from inside chlorinator.
15. Install washer and retaining nut on output control shaft.
16. Install output control knob and tighten set screw.
17. Push red line connector onto top edge of PCB (Note: locator plates in red line connector line up with slots in edge of PCB).
18. Reattach wire harness to back of chlorinator with new zip ties (to keep wire harness away from hot transformer).
19. Replace cover with 4 screws.
20. Replace chlorinator on wall bracket.
21. Reconnect power supply.
22. Test chlorinator functions.

Bridge Rectifier

Checking Diode / Replacing Rectifier

Testing

1. Disconnect power supply.
2. Remove chlorinator from wall bracket.
3. Remove 4 screws to remove cover.
4. Detach output cord and sensor wire from cell.
5. Detach power cord from power supply.
6. Use multi-meter set on diode test mode and test as follows;
 - Place 1 probe on each of the red wire posts of the rectifier and note the meter reading.
 - Switch probe location and place on opposite red wire posts and note meter reading.
 - If you get a change in meter reading during only one of the tests, that diode is good (continue testing).
 - If you get a change in meter reading during both tests, that diode is bad. Rectifier must be replaced.
 - Place 1 probe on each of the black wire posts of the rectifier and note the meter reading.
 - Switch probe location and place on opposite black wire posts and note meter reading.
 - If you get a change in meter reading during only one of the tests, that diode is good (go to step 11).
 - If you get a change in meter reading during both tests, that diode is bad. Rectifier must be replaced.

Replacement

7. Cut all wires to bridge rectifier as close as possible.
8. Use 5/16" socket to remove bolt from center of rectifier and remove old rectifier.
9. Cover back of new rectifier with heat sink compound and bolt tightly in place (notched corner goes to bottom right).
10. Strip and solder wires in this order;
 - Bottom right = red output cord and small red wire from line connector
 - Bottom left = black from transformer
 - Top right = red from transformer
 - Top left = black to output meter (may have small black from line connector also)
11. Attach power cord to power supply.
12. Replace cover with 4 screws.
13. Replace chlorinator on wall bracket.
14. Attach output cord and sensor wire to cell.
15. Reconnect power supply.
16. Test chlorinator functions.



Red Line Connector Assembly (Large)

Note: The PCB should also be replaced if the red line connector shows signs of burning or melting inside.

To Remove

1. Disconnect power supply.
2. Remove chlorinator from wall bracket.
3. Remove 4 screws to remove cover.
4. Clip 3 zip ties that hold wire harness to back of chlorinator.
5. Loosen and remove Dk. Blue and Red wires (coming from red line connector) from white terminal at top of transformer.
6. Loosen and remove Lt. Blue and Green/Yellow wires (coming from red line connector) from white terminal at power cord.
7. Use flat blade screwdriver to pull red line connector off top edge of PCB.
8. Turn output control knob counter-clockwise to expose setscrew in knob.
9. Remove output control knob.
10. Remove retaining nut and washer from output control shaft.
11. Gently push all 3 lights and shaft through face from front of chlorinator and remove assembly.

Replacement

12. Remove nut from shaft of new output control board.
13. Gently push all 3 lights and shaft in place from inside chlorinator.
14. Replace washer and retaining nut on output control shaft.
15. Install output control knob and tighten setscrew.
16. Push large red line connector onto top edge of PCB (Note: locator plates in red line connector line up with slots in edge of PCB).
17. Insert and tighten 2 Red (to Brown) and Dk. Blue (to White) wires to white terminals at top of transformer.
18. Insert and tighten Lt. Blue (to Black or White) and Green/Yellow (to Green) wires to white terminal at power cord.
19. Reattach wire harness to back of chlorinator with new zip ties (to keep wire harness away from hot transformer).
20. Replace cover with 4 screws.
21. Replace chlorinator on wall bracket.
22. Connect power supply.

Note: You can cut the red line connector in half and replace only the output control half OR the power input half. Use heavy-duty snips to cut the red line connector.

Red Line Connector (Small)

To Remove

1. Disconnect power supply.
2. Remove chlorinator from wall bracket.
3. Remove 4 screws to remove cover.
4. Use flat blade screwdriver to pull small red line connector off bottom edge of PCB.
5. Pull small red line connector through to left side of chlorinator for easier access to wires.
6. Unsolder 4 wires from small red line connector (make note of color positions).

Replacement

7. Solder 4 wires to new small red line connector.
8. Feed small red line connector past back of transformer and push onto bottom edge of PCB (Note: locator plate in red line connector lines up with slot in edge of PCB).
9. Replace cover with 4 screws.
10. Replace chlorinator on wall bracket.
11. Connect power supply.

Wire Color Locations

From right end, while looking at PCB.

Red Line Connector (Large)

Yellow (right end)
Blue
Locator
Brown
Black
Red
Green
Orange
Blank
Blank
Blank
Blank
Green/Yellow
Blank
Red
Locator
Lt. Blue
Blank
Dk. Blue (left end)

Red Line Connector (Small)

White (right end)
Black
Red
Gray
Locator (left end)

Power Cord

Replacement

1. Disconnect power supply.
2. Remove chlorinator from wall.
3. Remove 4 screws to remove cover.
4. Loosen 3 screws in white power cord terminal to disconnect power cord wires.
5. Use pliers to squeeze base of power cord grip grommet and pull through hole from the outside.
6. Remove power cord grip grommet and transfer to new power cord (one side of the grommet will separate from the rest).
7. Push power cord grip grommet with new power cord through hole from the outside till it snaps in place.
8. Insert power cord wires into appropriate terminal openings (green to green, black and white are interchangeable in remaining spaces) and tighten screws firmly.
9. Replace cover with 4 screws.
10. Replace chlorinator on wall.
11. Connect power supply.

Note: Power Cord is ETL approved at 3 foot long. If additional power cord is required it should be extended by using a j-box and hard wiring in shielded conduit to the power supply. Only use an ETL approved replacement cable.

Output Cord

Replacement

1. Disconnect power supply.
2. Remove chlorinator from wall.
3. Remove 4 screws to remove cover.
4. Cut 3 wires of output cord just inside unit.
5. Cut zip tie holding small black wire to cord grip grommet.
6. Use pliers to squeeze base of cord grip grommet and pull cord through hole from the outside.
7. Remove cord grip grommet and transfer to new output cord (one side of grommet will separate from the rest).
8. Push cord grip grommet with new output cord through hole from the outside till it snaps in place.
9. Strip all wire ends to be joined.
10. Slide heat shrink on one end of each wire pair.
11. Splice together like color and size wires with correct size butt connector.
12. Slide heat shrink over splice and use heat gun or hair dryer to shrink.
13. Replace Cover with 4 screws.
14. Replace chlorinator on wall.
15. Connect power supply.

Using Conversion Kit

(Replacing Output Cord ends only)

1. Cut the old terminals off existing output cord below damage (see note below).
2. Slide black outer heat shrink over existing cord.
3. Strip each wire insulation.
4. Slide inner heat shrink on individual wires (red to red, and black to black).
5. Position the butt connectors over exposed wires and crimp tightly using crimping tool.
6. Slide inner heat shrinks over crimped joints evenly and use heat gun or hair dryer to shrink.
7. Slide plastic insulation on conversion cord towards the crimp joints as far as possible.
8. Slide outer heat shrink over entire cord and crimp joints.
9. Use a heat gun or hair dryer to shrink outer heat shrink.

Note: Recommend to stagger cord cuts slightly as to not end up with all 3 butt connectors side by side. This will make it easier to slide outer heat shrink in place.

Transformer

Testing

See Testing the Power Path pg. 4.

Replacement

1. Disconnect power supply.
2. Remove chlorinator from wall.
3. Remove 4 screws to remove cover.
4. Disconnect from the three white plastic terminals all wires that lead to the transformer. Keep track of each wire location for reassembly.
5. Remove the rivets holding the transformer in place.
6. Mount new transformer using washers & new rivets.
7. Relocate white terminals to top of transformer and mount with screws.
8. Attach wires from new transformer to correct plastic terminals.
9. Attach cover with 4 screws.
10. Replace chlorinator on wall.
11. Reconnect power supply.

Cell



WARNING

Cell is under pressure! Make sure that the pump is off and that the pressure has been released by opening the air-bleed valve on top of the filter before removing the cell.

Check the Condition of the Cell

- Always clean cell and check operation before replacing.
- To test operation, install new cell or test cell on line.
- Do not allow build-up to get heavy enough to bridge 2 plates together.
- Brittleness is sign of damage to the cell. Replace the cell.

Heavy Build-up on Cell

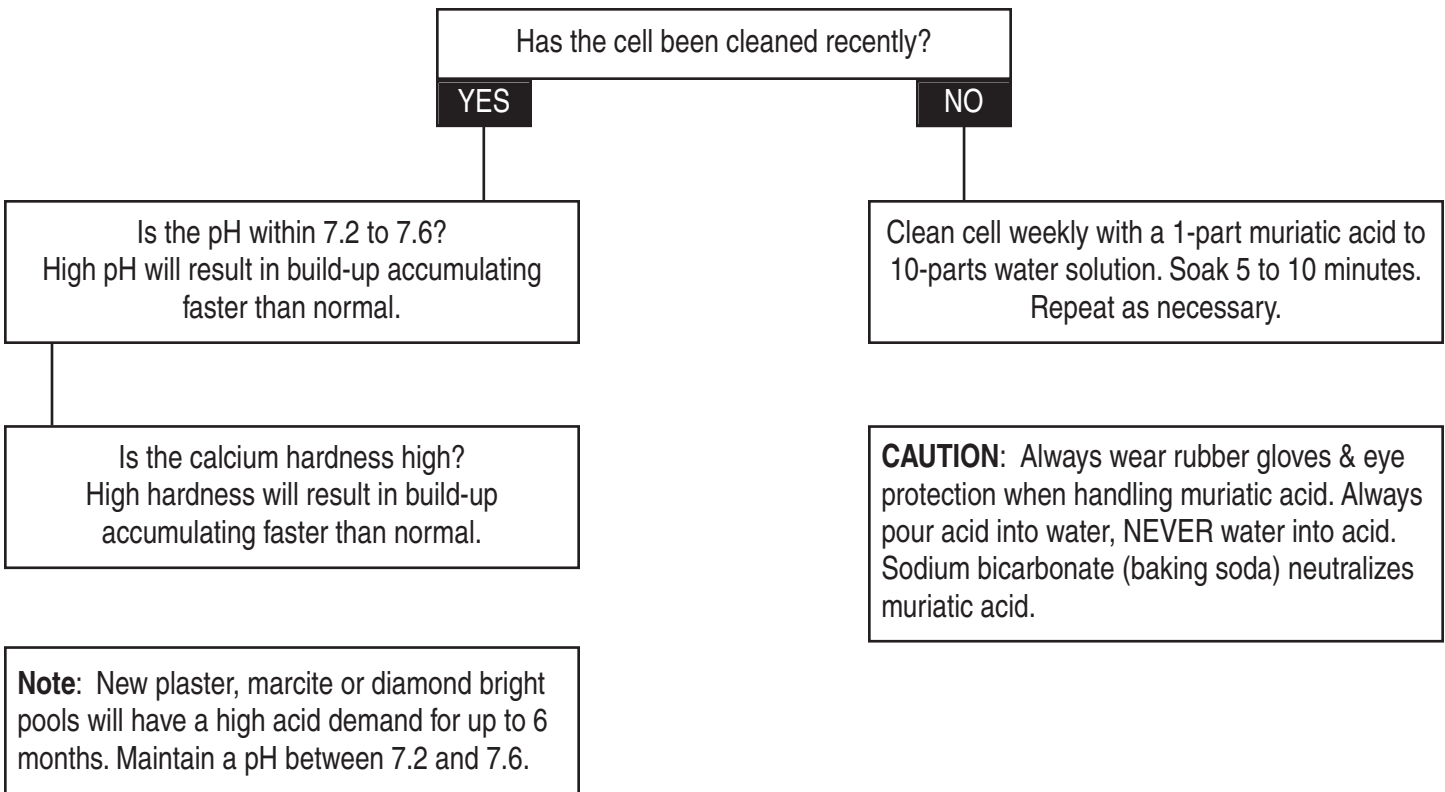

Replace Cell

1. Turn off power supply.
2. Detach output cord and sensor wire from cell.
3. Unscrew electrode end cap.
4. Screw new electrode into cell housing (hand tight only).
5. Attach output cord and sensor to cell.
6. Turn on power supply.

Cell Cap

If leaking from center ring of cap:

1. Turn off power supply.
2. Unscrew cell cap.
3. Clean / lube O'ring and mating surfaces OR replace with new pre-lubed O'ring.
4. Screw cap in place (hand tight only).
5. Turn on power supply.

Replace Blank End Cap

1. Turn off power supply.
2. Unscrew old cap.
3. Clean O'ring mating surface.
4. Screw on new cap with new o'ring pre-lubed (hand tight only).
5. Turn on power supply.

Replace Electrode End Cap

1. Turn off power supply.
2. Detach output cord and sensor wire from cell.
3. Unscrew electrode end cap.
4. Slide color sleeve from black terminal socket.
5. Loosen setscrew to remove terminal socket (set with black sleeve).
6. Slide color sleeve from red terminal socket.
7. Loosen set screw to remove terminal socket (set with red sleeve). **The terminal sockets are not the same size and must be kept track of!**
8. Remove, clean, and lube both electrode post O'rings (may be stuck in cap).
9. Put electrode post O'rings in cap and slide on "post spacers".
10. Slide new cap onto electrode posts so that the post attached to the outside plates is near the flow sensor (this will be the black socket location).
11. Slide black terminal socket onto post nearest sensor and firmly tighten with setscrew.
12. Slide black color sleeve onto terminal.
13. Slide red terminal socket onto remaining post and firmly tighten with setscrew.
14. Slide red color sleeve onto terminal.
15. Screw electrode into cell housing (hand tight only).
16. Attach output cord and sensor to cell.
17. Turn on power supply.

C Series Powerpack

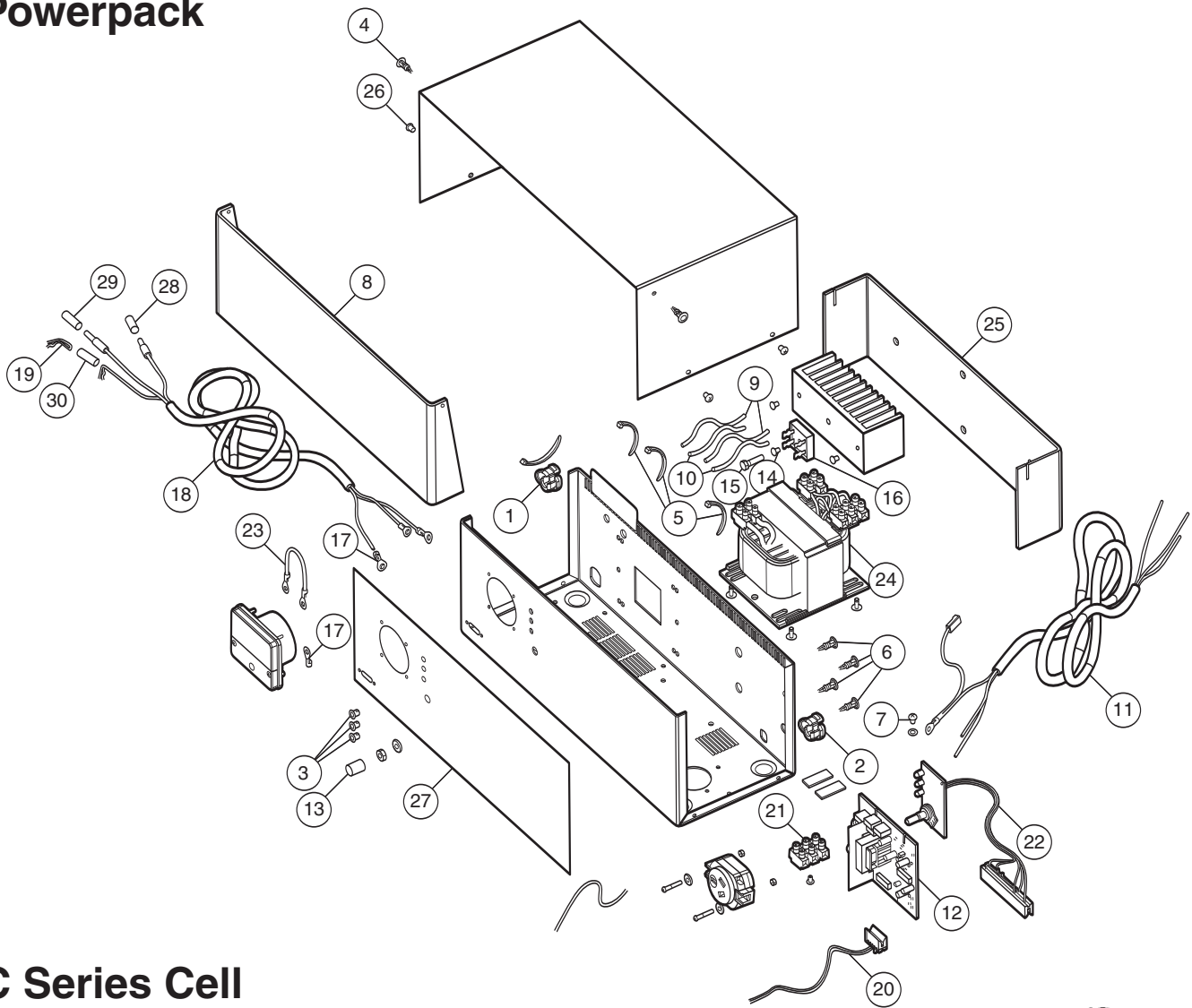

C Series Cell

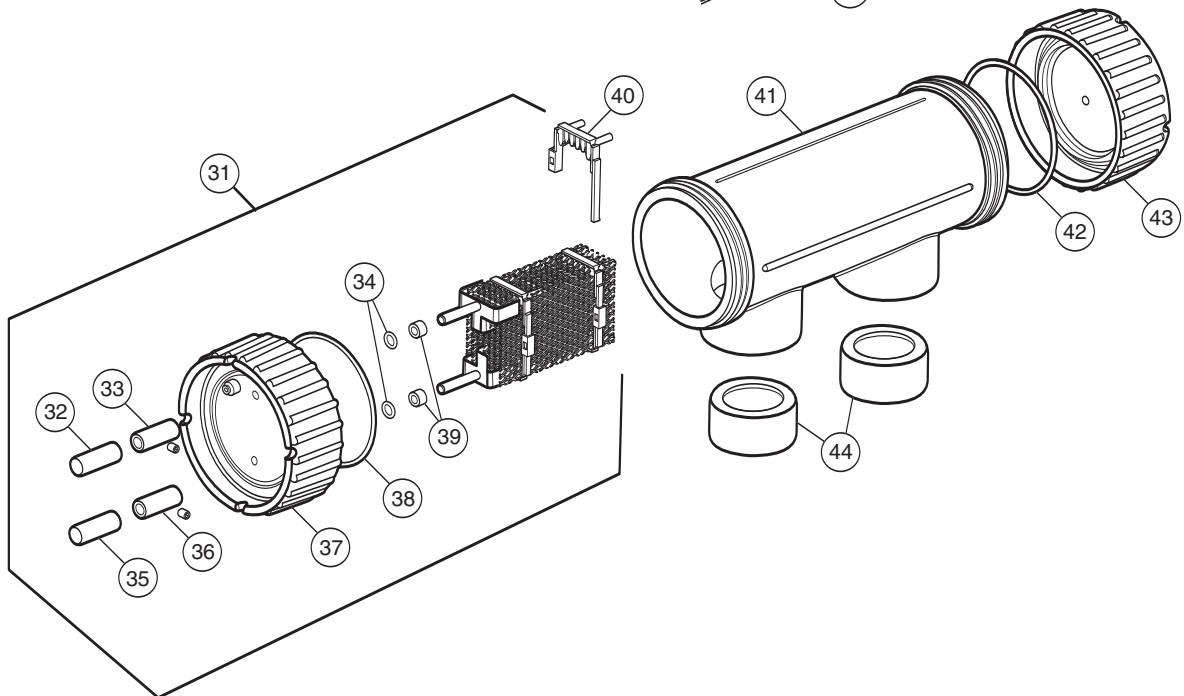

C Series - USA

C Series Powerpack

No.	Part #	Description	Qty
1	W000011	Output Cord Grommet	
2	W000021	Input Cord Grommet HE1217/6N-4	
3	W000031	LED Bezels	
4	W000041	Canoe Clip	
5	W000051	Cable Tie	
6	W000071	PCB Standoffs	
7	W000201	Earth Screw	
8	W010181	Acrylic Front Cover	
9	W050351	Rectifier Wire Red	
10	W050361	Rectifier Wire Black	
11	W051431	Input Cable - C	
12	W080341	Main PCB	
13	W100051	Output Control Knob	
14	W000271	Spring Washer	
15	W000571	Rectifier Screw	
16	W060401	Rectifier	
17	W120021	Lugs	
18	W190891	Output Cable With Terminals	
19	W140101	Sensor Clip	
20	W190941	4 Wire Redline Assembly	
21	W120201	3 Way Terminal Strip	
22	W191181	Manual Control for PCB Assembly	
23	W191101	Shunt For C140	
	W191111	Shunt For C170	
	W191131	Shunt For C200	
	W191151	Shunt For C250	
24	W130031	Transformer (All Models)	
25	W010131	Mounting Bracket	
26	W000581	Cover Screws	
27	W170021	Front Label	
28	W050041	Cell Terminal Insulation Black	
29	W050051	Cell Terminal Insulation Red	
30	W050681	Sensor Insulation Black	

C Series Cel

No.	Part #	Description
31	W193841	C140 Electrode Kit
	W193851	C170 Electrode Kit
	W193861	C200 Electrode Kit
	W193871	C250 Electrode Kit
	W193991	C400 Electrode Kit (2 Cells Required)
32	W050061	Heatshrink Black
33	W050071	Heatshrink Red
34	W190801	Brass Socket Negative
35	W190811	Brass Socket Positive
36	W192021	Cell Cap (Electrode Side)
37	W150041	O-Ring, Cell Cap
38	W150021	O-Ring, Electrode Post
39	W040351	Post Spacer
40	W040011	Electrode Clips
41	W193741	Cell Housing
42	W041101	Reducing Bush (White)
43	W193821	Blank Cap



ZODIAC POOL CARE, INC.
2620 Commerce Way
Vista, CA 92081
1-800-822-7933
www.zodiacpoolcare.com